

**EVERLASTING  
COMPANY**



**TEKSAN USA**

WE DELIVER POWER TO THE WORLD



**WHENEVER YOU NEED  
POWER, WE ARE  
ALWAYS WITH YOU...  
SINCE 1994!**

Since 1994, Teksan has been delivering high quality tailormade solutions that are designed accordingly to your requirements with strong after-sales technical support and maintenance services anytime and anywhere you need uninterrupted power supply. When your company is moving further ahead rapidly on the road to success, you always feel our continuous support as your reliable power solutions partner.  
*Because Teksan is a member of your family...*



## IN TEKSAN "PEOPLE" COME FIRST...



**T**eksan, who aims to deliver uninterrupted power solutions to the people through sustainable improvement and innovation, designs and installs high quality diesel, natural and biogas driven generator sets, mobile lighting towers, portable generator sets, cogeneration-trigeneration solutions and hybrid power systems that exceed the expectations of the customers.



For more than 25 years, thanks to its solid experience and engineering know-how, Teksan has been providing tailor-made power solutions that can efficiently operate even under the most challenging conditions for major international projects such as constructions, telecommunications, data centers, shopping centers, hotels, residential buildings, supermarkets, sport centers, mining facilities, hospitals, research centers, educational institutions and industrial plants all around the world.

Today, thanks to its high quality generator sets approved with international quality certifications which are made of world's top engine brands coupled to well known alternators to meet projects' requirements of different output ranges, and strong after-sales technical support and maintenance services in more than 130 countries, Teksan is always your reliable power solutions partner whenever and wherever you need.



# MILESTONES OF SUCCESS...



1994 1996 2000 2003 2004 2005 2007 2011 2012 2013 2014 2015 2016 2017 2018 2019 2020 2021

Established under the name "Deniz Mühendislik Ltd. Şti." and began its activities.

Changed its name as Teksan Jeneratör Elektrik Sanayi ve Ticaret A.Ş.

Increased its product range upper limit from 880 kVA to 2250 kVA.

Moved to Sancaktepe Plant. Power upper limit was increased from 2250 kVA to 3550 kVA.

R&D Department has been established.

Produced the first national natural gas generator set of Turkey.

Developed the first domestic production cogeneration systems of Turkey.



With its special project with 2x3125 kVA - 11 kV alternators, Teksan produced the biggest generator sets in Turkey until today.

Teksan carried out the most comprehensive ERP project of the industry.

Realised the first trigeneration system project with 4x500 kW gas engine.

Teksan was named among the in TIM's "Top 1000 Exporters of Turkey" list.



Teksan Generator started Teksan Production System (TÜS).



Innovated the first national Hybrid Power System in Turkey.

Launched the power solutions that powered with biogas.

Increased the number of countries exported to 120.



Kocaeli factory has started to operate.

Being recognised as a R&D Centre by the Ministry of Science, Industry and Technology, Teksan Generator has become the first private R&D centre in the industry.

Ranked Fortune 500 Turkey list from the 469th place.



Chosen for the TUBITAK-TEYDEB Success Stories Booklet with the first domestic Hybrid Generator Set of Turkey.

Launched the first and only "Hybrid Lighting Tower" of Turkey to its product range.

Ranked 436th in TIM 1000 and ISO 500 lists.

Moved up to the 97th place in the list of 250 leading R&D companies of Turkey.



Celebrated its 25th years in the industry.

Teksan UK was established.

Awarded the Authorized Economic Operator (AEO) Certificate.

Has once again proved its quality and reliability by obtaining the UL Certificate.

Managed to enter the Turquality Brand Support Program.

Increased the number of countries exported to 130.



In order to improve all production-logistics processes, the transition was made to "Teksan Değişim Yönetimi" (TDY), which enables continuous improvement of quality, efficiency, security and delivery.

Teksan successfully completed the seismic certification process of its generator sets.



# TEKSAN QUALITY IS NOT A COINCIDENCE!

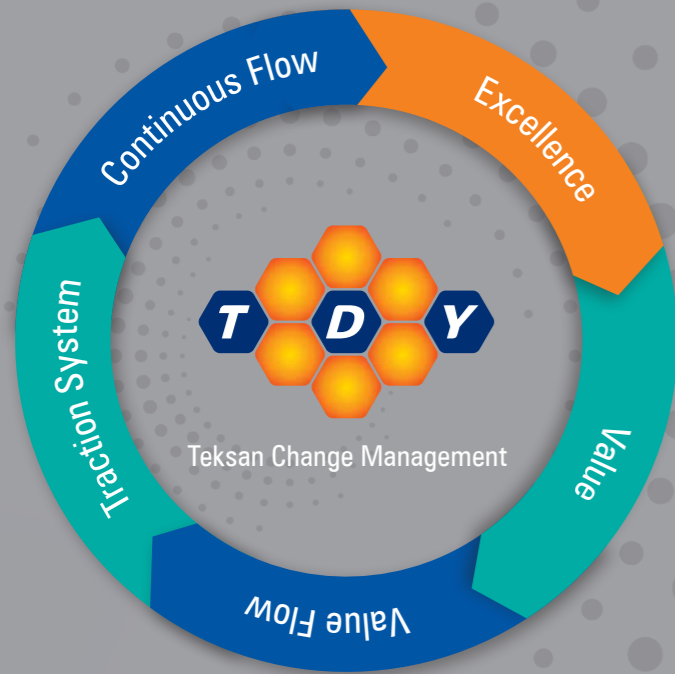

**TDY** Teksan Change Management (TDY) covers all known systems, unlike those it allows to focus on the greatest loss. Its realization is supported by an audit system and measured by appropriate Performance Indicators (KPI). TDY aims to achieve operational excellence, improve business results by increasing productivity, improve product and service quality to increase customer satisfaction, to manage the company by using auditable work flows and measurable goals, and to educate the future senior managers and the leader candidates.

## QUALITY CERTIFICATES AND DOCUMENTS



Producing high quality solutions with proper price that meets continuously-changing customer needs beyond expectations and delivering timely solutions are the most important objectives of Teksan's Quality Policy. In line with this aim, Teksan, which carries out all its activities with international standards, as well as Teksan Production System, Quality Management System, Environmental Management, Occupational Health and Safety system are established by Teksan, has lots of international certificates and documents as 2000/14/EC Noise Emission Certificate, ISO 9001, ISO 14001, SONCAP Product Certificate, ISO 45001, CE Certificate, EAC Certificated, UL Listed, TSE Service Competency Certificate and Turkish Standart Compliance Certificates, takes part among most reliable and most preferable companies of sector in power solutions with providing uninterruptedly pre-sales and after sales technical support.



# TEKSAN'S HIGH STANDARDS!



## THERMAL ANALYSIS

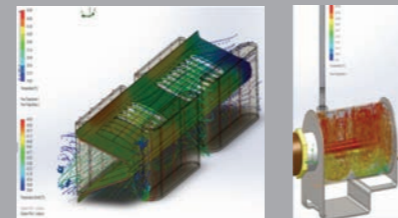

## FINITE ELEMENTS ANALYSIS

- Static Analysis,
- Dynamic Analysis,
- Natural Frequency Analysis,
- Fatigue Analysis,
- Nonlinear Analysis.

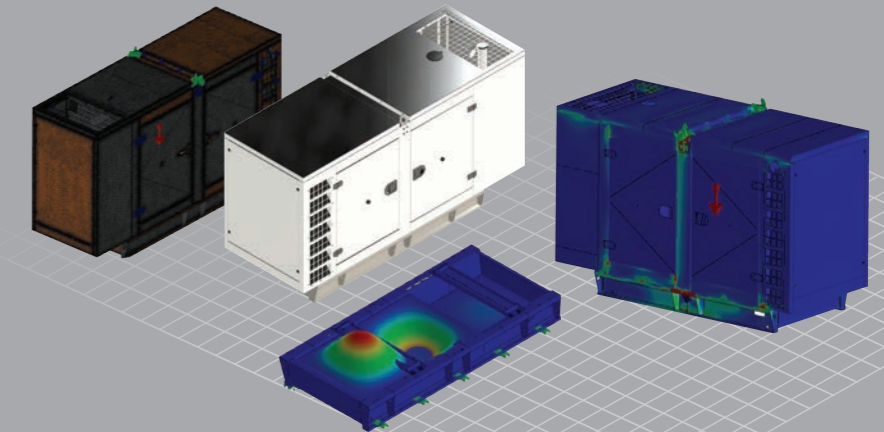

## TESTS

- Voltage Measurement Implementations,
- Vibration Test,
- Acoustic Test,
- Temperature Test,
- Performance Test.

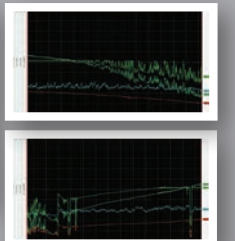
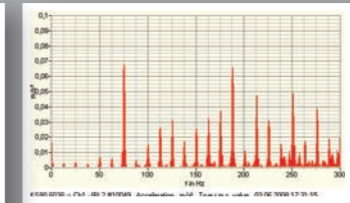
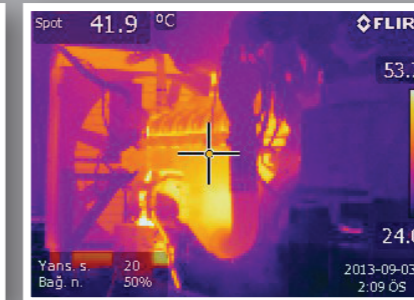

## COMPUTATIONAL FLUID DYNAMICS

- Cabin Flow Optimization,
- Exhaust muffler
- Back Pressure Analysis.

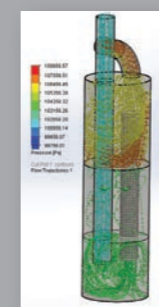

## ELECTRICAL TESTS

- Insulation Test,
- Working scenarios simulation,
- Harmonic Measurement,
- Temperature control.

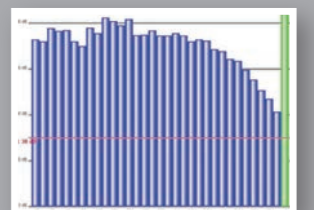

## LISTEN VERY CAREFULLY!

THANKS TO  
ULTRA SILENT CANOPIES,  
NOT ONLY YOUR GENSETS  
BUT ALSO YOUR EARS  
ARE PROTECTED!

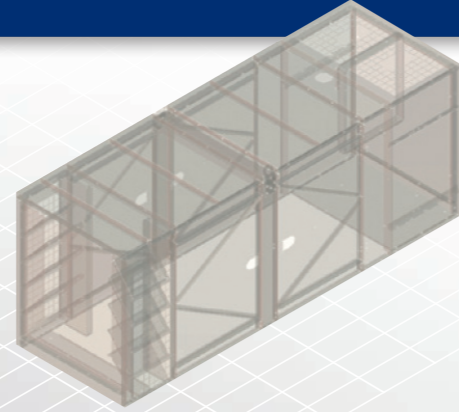

## STANDARD TYPE CANOPY



HIGH PROTECTION  
AGAINST  
CORROSION AND  
RUST

MAKING  
DIFFERENCE IN  
PERFORMANCE IN  
TERMS OF SOUND  
INSULATION

DESIGN  
WITH MAKING  
TRANSPORTATION  
AND MAINTENANCE  
EASIER

SAFE  
USAGE

- Compatible with 2000/14/EC directives, certified noise emission level,
- 2 or 4 points transport possibility according to cabin size,
- Hidden exhaust inside the canopy,
- Emergency stop button located on the canopy,
- Improved air suction channel to ensure homogenous cooling in the canopy,
- Radiator air outlet and exhaust with designed towards above,

- Lid on cab that provides to be filled up water and antifreeze easily to the radiator,
- Amplified paint system against corrosion and rusting,
- Improved performance in terms of sound insulation,
- Demounted parts that make transportation and maintenance easier,
- In accordance with customer requests, private canopy production with desired sound level/size.



## LIGHTING TOWERS

Lighting Towers, which are ideal for enlighting of construction sites, concrete works, road-bridge production works and outdoor organizations that are in open area and their usage places replace frequently, can also be produced with private sound level in accordance with customer requests.

## ALL CONTROL IS IN YOUR HANDS

### YOUR ENERGY IS UNDER "CONTROL"

**S**tandard control panels, that are used in Teksan sets, provide comfort and confidence in usage with all required indicators. Special control panels, that can satisfy all needs, are designed in accordance with requests of our customers.



#### AUTOMATIC CONTROL PANEL

Automatic Control Panel is designed according to generator groups that are used as back up of grid. It steps in automatically when grid electricity is cut and transfers the electricity that obtains from generator set to the system. In case of return of grid power, automatic control panel transfers the load to the grid and halts generator automatically. It has electronic control unit with protection and control specific and micro processor for working of engine and alternator group healthfully. As well as this unit gives a possibility to conn automatic-manuel-test at inert-test at load position, it also includes measurement equipments for visual control.

#### MANUEL CONTROL PANEL

Manuel Control Panel is designed for generator groups which are desired to connect manually. Especially, it is preferred in the absence of grid electricity power. Manuel control panel provides taking of protection precautions, monitoring and implementing of control operations. Micro processor electrical control module provides protection precautions.

## EXTENSIVE OPTIONS FOR MORE POWER...



**T**hanks to its engineers, that are experts in their subjects, Teksan offers you much more than a generator set by putting your needs in the first place.



WHAT DOES TEKSAN SYNCHRONIZATION PROJECT PROVIDE YOU?



**S**ynchronization is to mount the same common busbar after the comparison of two or more generators groups' voltage frequency value's phase alignments and angles. Synchronous groups meet current load by sharing in ratio of their forces and work or stop automatically according to load alteration.

Thus, synchronous groups provide economic advantages and security. With purchasing single group generator set by identifying initial need, establishment's initial investment cost can be decreased and important savings in fuel consumption can be provided. Synchronized generator set provides remote control possibility to all functions by communicating with components as PLC computer, network, modem. Thanks to synchronized generator set transmits information to automatisaion systems, economy and security reach to high level.



# DIESEL GENSETS

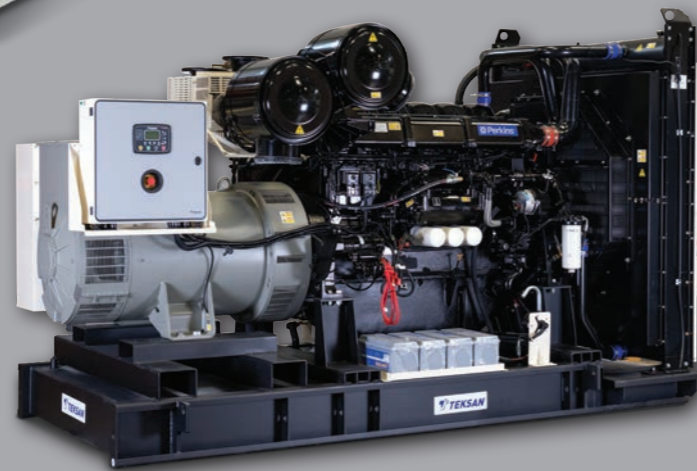

## 60 Hz Product Range – Standby Stationary Diesel



Genset Model	Perkins Engine	EPA Engine Emission	Alternator	Genset Standby Power - KW					
				480/277V	208/120V	240/120V	600/347V	240/120V - 1Ph	240/120V - 1Ph
				(WYE)	(WYE)	(DELTA)	(WYE)*	(1Ph-DD)	(1Ph - SE)**
TJUD9P	403D-11G	Tier 4 Final (ESE)	Leroy Somer	9,00	9,00	9,00	9,00	9,00	9,00
TJUD13P	403D-15G	Tier 4 Final (ESE)	Leroy Somer	13,00	13,00	13,00	13,00	13,00	13,00
TJUD20P	404D-22G	Tier 4 Interim	Leroy Somer	20,00	20,00	20,00	20,00	19,00	21,00
TJUD25P	404D-22TG	Tier 4 Interim	Leroy Somer	25,00	25,00	25,00	25,00	19,00	26,00
TJUD28P	404D-22TG	Tier 4 Interim	Leroy Somer	28,00	28,00	28,00	28,00	23,00	29,00
TJUD30P	404D-22TAG	Tier 4 Interim	Leroy Somer	31,00	32,00	32,00	31,00	24,00	31,00
TJUD50P	1104D-44TG1	Tier 3	Leroy Somer	50,00	52,00	52,00	49,00	39,00	53,00
TJUD55P	1104D-44TG1	Tier 3	Leroy Somer	57,00	57,00	57,00	56,00	46,00	56,00
TJUD60P	1104D-E44TG1	Tier 3	Leroy Somer	60,00	60,00	60,00	64,00	52,00	63,00
TJUD65P	1104D-E44TG1	Tier 3	Leroy Somer	64,00	65,00	65,00	64,00	59,00	63,00
TJUD80P	1104D-E44TAG1	Tier 3	Leroy Somer	80,00	85,00	85,00	85,00	65,00	80,00
TJUD100P	1104D-E44TAG2	Tier 3	Leroy Somer	100,00	106,00	106,00	100,00	76,00	100,00
TJUD125P	1106D-E70TAG2	Tier 3	Leroy Somer	125,00	130,00	130,00	125,00	95,00	125,00
TJUD150P	1106D-E70TAG2	Tier 3	Leroy Somer	150,00	150,00	150,00	150,00	140,00	
TJUD160P	1106D-E70TAG3	Tier 3	Leroy Somer	160,00	160,00	160,00	160,00	152,00	
TJUD175P	1106D-E70TAG4	Tier 3	Leroy Somer	180,00	175,00	175,00	180,00	165,00	
TJUD180P	1106D-E70TAG4	Tier 3	Leroy Somer	180,00	182,00	182,00	180,00	176,00	
TJUD200P	1106D-E70TAG5	Tier 3	Leroy Somer	200,00	200,00	200,00	205,00	200,00	
TJUD250P	1706D-E93TAG1	Tier 3	Leroy Somer	250,00	250,00	250,00	255,00	230,00	
TJUD275P	1706D-E93TAG2	Tier 3	Leroy Somer	275,00	275,00	275,00	275,00		
TJUD300P	1706D-E93TAG2	Tier 3	Leroy Somer	300,00	300,00	300,00	300,00		
TJUD315P	1706D-E93TAG2	Tier 3	Leroy Somer	320,00	315,00	315,00	320,00		
TJUD350P	2206D-E13TAG2	Tier 3	Leroy Somer	350,00	350,00	350,00	350,00		
TJUD400P	2206D-E13TAG3	Tier 3	Leroy Somer	405,00	405,00	405,00	400,00		
TJUD450P	2506D-E15TAG1	Tier 3	Leroy Somer	455,00	450,00	450,00	455,00		
TJUD500P	2506C-E15TAG3	Tier 2	Leroy Somer	500,00	500,00	500,00	500,00		
TJUD530P	2506C-E15TAG3	Tier 2	Leroy Somer	530,00	530,00	530,00	530,00		
TJUD550P	2506C-E15TAG4	Tier 2	Leroy Somer	550,00	560,00	560,00	550,00		
TJUD600P	2806C-E18TAG3	Tier 3	Leroy Somer	600,00	610,00	610,00	600,00		
TJUL750P	2806C-E18TAG7	Tier 3	Leroy Somer	750,00	750,00	750,00	750,00		
TJUL800P	5008C-E30TAG4	Tier 2	Leroy Somer	820,00	800,00	800,00	800,00		
TJUL865P	5008C-E30TAG4	Tier 2	Leroy Somer	895,00	865,00	865,00	880,00		
TJUL900P	5008C-E30TAG4	Tier 2	Leroy Somer	900,00	900,00	900,00	900,00		
TJUL1000P	5008C-E30TAG5	Tier 2	Leroy Somer	1000,00	1000,00	1000,00	1000,00		



Single phase units power ratings are given at pf 1.0

\* 600/367V WYE connection is available with only 12 leads special winding alternator.

\*\* 240/120V - 1Ph Series connection is available with only 4 leads alternator.



## NATURAL GAS / LPG GENSETS

WE PROVIDE **TURN-KEY POWER PACKAGES** THAT ENSURE UNINTERRUPTED OPERATION OF YOUR PRODUCTION...

**A**s Teksan, with our experience of a quarter century and strong engineering know-how, we add strength and value to the energy industry with our cogeneration-trigeneration solutions and our hybrid systems, and diesel and gas generators sets with international quality certificates used by engine and alternator brands that are known worldwide for their quality and performance and which operate with high performance under the toughest conditions. Our company, which has become of the leading companies in the energy industry not only with its production infrastructure but also with its investments in human resources and R&D, offers uninterrupted power solutions to a number of important projects in more than 130 countries, primarily factories, and manufacturing and power plants of various sizes and our expert technical team provides the service and spare parts support fast and effectively.



### 60 Hz Product Range – Standby Gaseous



Genset Model	PSI Engine	Alternator	Genset Standby Power - NG / LPG (kW)					
			480/277V	208/120V	240/120V	600/347V	240/120V - 1Ph	240/120V - 1Ph
			(WYE)	(WYE)	(DELTA)	(WYE)*	(1Ph-DD)	(1Ph - SE)**
TJUG25PS	PSI 2.4L	Leroy Somer	25 / 25	25 / 25	25 / 25	25 / 25	19 / 19	25 / 25
TJUG40PS	PSI 4.3L	Leroy Somer	40 / 40	40 / 40	40 / 40	40 / 40	34 / 34	40 / 40
TJUG60PS	PSI 5.7L NA	Leroy Somer	60 / 60	60 / 60	60 / 60	60 / 60	52 / 52	60 / 60
TJUG80PS	PSI 5.7LT	Leroy Somer	80 / NA	80 / NA	80 / NA	80 / NA	65 / NA	80 / NA
TJUG100PS	PSI 5.7LT CAC	Leroy Somer	100 / 80	100 / 80	100 / 80	100 / 80	76 / 76	100 / 80
TJUG115PS	PSI8.8LNA	Leroy Somer	100 / 115	100 / 115	100 / 115	100 / 115	81 / 81	100 / 115
TJUG125PS	PSI8.8LT	Leroy Somer	125 / NA	125 / NA	125 / NA	125 / NA	95 / NA	125 / NA
TJUG150PS	PSI 8.8LT CAC	Leroy Somer	150 / 125	150 / 125	150 / 125	150 / 125	150 / 125	125 / 125
TJUG200PS	PSI 10LT	Leroy Somer	200 / 140	200 / 140	200 / 140	200 / 140	200 / 140	
TJUG200PD	PSI 11.1L	Leroy Somer	200 / 135	200 / 135	200 / 135	200 / 135	200 / 135	
TJUG250PS	PSI 13L	Leroy Somer	250 / 150	250 / 150	250 / 150	250 / 150	230 / 150	
TJUG275PD	PSI 14.6L	Leroy Somer	275 / 200	275 / 200	275 / 200	275 / 200	230 / 200	
TJUG300PD	PSI 14.6L	Leroy Somer	300 / 200	300 / 200	300 / 200	300 / 200		
TJUG350PD	PSI 14.6LHO	Leroy Somer	350 / NA	350 / NA	350 / NA	350 / NA		
TJUG400PD	PSI 21.9L	Leroy Somer	400 / 300	400 / 300	400 / 300	400 / 300		
TJUG450PD	PSI 21.9L	Leroy Somer	450 / 300	450 / 300	450 / 300	450 / 300		
TJUG500PD	PSI 21.9LHO	Leroy Somer	500 / NA	500 / NA	500 / NA	500 / NA		
TJUG600PS	PSI 32L	Leroy Somer	600 / 400	600 / 400	600 / 400	600 / 400		
TJUG650PS	PSI 32L	Leroy Somer	650 / 425	650 / 425	650 / 425	650 / 425		
TJUG800PS	PSI 40L	Leroy Somer	800 / 475	800 / 475	800 / 475	800 / 475		
TJUG1000PS	PSI 52.8L	Leroy Somer	1000 / 700	1000 / 700	1000 / 700	930 / 700		
TJUG1050PS	PSI 52.8L	Leroy Somer	1050 / 700	1050 / 700	1050 / 700	1050 / 700		
TJUG650PS	PSI 32L	Leroy Somer	650 / 400	650 / 400	650 / 400	650 / 400		
TJUG800PS	PSI 40L	Leroy Somer	800 / 475	800 / 475	800 / 475	800 / 475		
TJUG1050PS	PSI 52.8L	Leroy Somer	1000 / 700	1000 / 700	1000 / 700	1000 / 700		

\* 600/367V WYE connection is available with only 12 leads special winding alternator.  
 \*\* 240/120V - 1Ph Series connection is available with only 4 leads alternator.

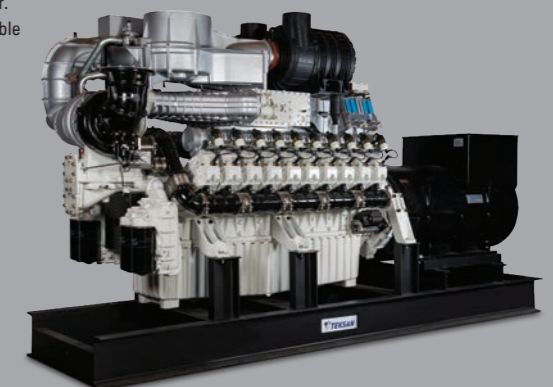

# AGRICULTURE GENSETS



## WE POWER AGRICULTURE WITH EFFICIENT AND RELIABLE SOLUTIONS!



**A**s Teksan, with our experience of a quarter century and strong engineering know how, we add strength and value to the agriculture sector with our diesel generator sets with international quality certificates used by engine and alternator brands that are known worldwide for their quality and performance and which operate with high performance under the toughest conditions.



### 60 Hz Product Range – Standby Agriculture 1Phase 240/120V

Genset Model	Perkins Engine	EPA Engine Emission	Leroy Somer Alternator	Genset Standby Power - KW (pf 1.0)	
				240/120V - 1Ph	
				(1Ph-Double Delta)*	(1Ph - Series)**
TJAG50P	1104D-44TG1	Tier 3	Leroy Somer	56,00	53,00
TJAG60P	1104D-E44TG1	Tier 3	Leroy Somer	60,00	63,00
TJAG80P	1104D-E44TAG1	Tier 3	Leroy Somer	81,00	80,00
TJAG100P	1104D-E44TAG2	Tier 3	Leroy Somer	105,00	100,00
TJAG125P	1106D-E70TAG2	Tier 3	Leroy Somer	125,00	125,00
TJAG140P	1106D-E70TAG2	Tier 3	Leroy Somer	140,00	
TJAG150P	1106D-E70TAG3	Tier 3	Leroy Somer	150,00	
TJAG175P	1106D-E70TAG4	Tier 3	Leroy Somer	175,00	
TJAG200P	1106D-E70TAG5	Tier 3	Leroy Somer	200,00	
TJAG230P	1706D-E93TAG1	Tier 3	Leroy Somer	230,00	

\* Double Delta connection is available with only 12 leads alternator.  
 \*\* Series connection is available with only 4 leads alternator.

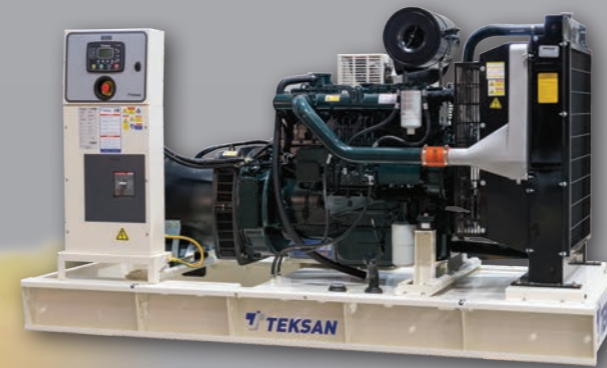

# MOBILE GENSETS



WE KNOW THE CHALLENGES OF YOUR BUSINESS, AND WE DESIGN **TAILOR-MADE SOLUTIONS** THAT EXCEED YOUR EXPECTATIONS...



Thanks to our high performing and robust solutions that are specially designed for mining industry, not only on the surface but also under the ground we are always there for you. With Teksan's quality products that have low fuel consumption, high efficiency rates even under the most challenging conditions such as dust, vibration, high or low temperature, you will always be on the safe side.

While custom-made power solutions of Teksan decrease your opex with their low fuel consumptions,

their robust structures minimize the risk of failure, their designs and state-of-the-art features provide easy maintenance. Not only with its reliable products but also with its comprehensive, fast technical and spare parts support, Teksan will deliver added value to your business.

Teksan not only manufactures mobile and stationary gensets with specially insulated canopies for the full protection against loud noise, fire as well as liquid contact, and can with optional features such as remote radiator, high capacity fuel tanks, remote monitoring system but also

safe-guards your uninterrupted power through its strong after-sales services...



## 60 Hz Product Range – Mobile Diesel Multi-Voltage

Genset Model	Engine	Engine Model	EPA	Alternator	Genset Standby Power - KW					
					480/277V		208/120V		240/120V, 1Ph*	
					Stand-by kW	Prime kW	Stand-by kW	Prime kW	Stand-by kW	Prime kW
TJT4F30DW	Doosan	D18	Tier 4 Final	Leroy Somer	32,00	28,00	32,00	28,00	27,50	27,50
TJT4F40DW	Doosan	D24	Tier 4 Final	Leroy Somer	43,00	39,00	43,00	39,00	34,00	34,00
TJT4F80DW	Doosan	D34	Tier 4 Final	Leroy Somer	81,00	73,00	81,00	73,00	76,00	73,00
TJT4F110V	Volvo	TAD571VE	Tier 4 Final	Leroy Somer	110,00	100,00	110,00	100,00	95,00	95,00
TJT4F140V	Volvo	TAD572VE	Tier 4 Final	Leroy Somer	140,00	125,00	140,00	125,00	125,00	125,00
TJT4F160V	Volvo	TAD871VE	Tier 4 Final	Leroy Somer	160,00	150,00	160,00	150,00	150,00	150,00
TJT4F180V	Volvo	TAD872VE	Tier 4 Final	Leroy Somer	180,00	165,00	180,00	165,00	165,00	165,00
TJT4F200V	Volvo	TAD873VE	Tier 4 Final	Leroy Somer	200,00	180,00	200,00	180,00	180,00	180,00
TJT4F200VH	Volvo	TAD1170VE	Tier 4 Final	Leroy Somer	200,00	200,00	200,00	200,00	190,00	190,00
TJT4F250V	Volvo	TAD1172VE	Tier 4 Final	Leroy Somer	250,00	225,00	250,00	225,00	215,00	215,00
TJT4F250VH	Volvo	TAD1371VE	Tier 4 Final	Leroy Somer	250,00	250,00	250,00	250,00	215,00	215,00
TJT4F300V	Volvo	TAD1373VE	Tier 4 Final	Leroy Somer	300,00	300,00	300,00	300,00	231,00	231,00
TJT4F350V	Volvo	TAD1375VE	Tier 4 Final	Leroy Somer	355,00	325,00	355,00	325,00		
TJT4F350VL	Volvo	TAD1670VE	Tier 4 Final	Leroy Somer	355,00	355,00	355,00	355,00		
TJT4F400V	Volvo	TAD1671VE	Tier 4 Final	Leroy Somer	400,00	400,00	400,00	400,00		
TJT4F460V	Volvo	TAD1672VE	Tier 4 Final	Leroy Somer	460,00	460,00	460,00	460,00		
TJT4F550V	Volvo	TAD1672GE	Tier 4 Final	Leroy Somer	550,00	500,00	550,00	500,00		
TJT4F620V	Volvo	TAD1673GE	Tier 4 Final	Leroy Somer	620,00	555,00	620,00	555,00		

\* Please consult factory for standard accessories and additional options.



POWER OF THE SUN IS WITH YOU!



## COGENERATION POWER PACKS

### STRONG SOLUTIONS FOR FUTURE

**TEKSAN, thanks to its solid experience and know-how, delivers high performing natural gas and biogas-based cogeneration-trigeneration solutions with energy efficiency up to 90%. You can get your investment back in a short period of 4-5 years.**

**C**ogeneration is to obtain energy more than one form from fuel. In Cogeneration, the basic principle is to benefit accumulated heat in the system to provide saving by considering the electricity needs of the facilities. In cogeneration systems, at the result of energy local production energy productivity is increased by providing electricity and temperature needs. And consequently, emission levels are gotten under control and carbon footprint is decreased.

Moreover, decreasing energy costs increase the profitability of the plant and nowadays, an advantage in competitive conditions that become more difficult is provided. According to electrical and thermal load trends, in applications the co-operation of multiple sets can be provided and cogeneration systems work under maximum load, energy production in the highest efficiency and lowest cost can be established.

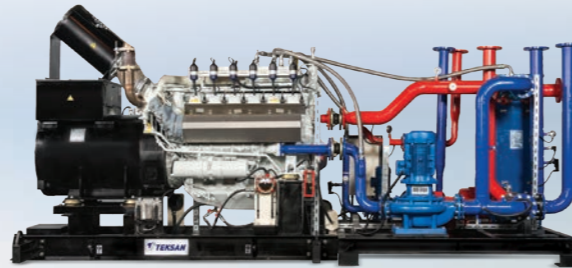

#### Advantages of Teksan Cogeneration Systems:

- Durable to work for many years, design that make it's dynamic and static analysis and calculations
- High efficiency due to it's equipment designed specially for cogeneration system
- Convenience in layout and maintenance course due to it's compact design,
- Investment return in short time thanks to feasibility calculations accurate analysis and suitable system design,
- Low maintenance costs,
- Ease of augmentation of system capacity upon demand and simultaneous operation with diesel generator sets
- In Teksan cogeneration systems, heat can be offered to the client in various ways. Along with standard hot air outlet, project based superheated steam and hot oil, cold water can be distributed too, in such projects which need cooling, via absorption chillers. Along with these, in greenhouses and projects that are demanding CO<sub>2</sub> usage, exhaust emissions are also utilisable.



Turbo Charger

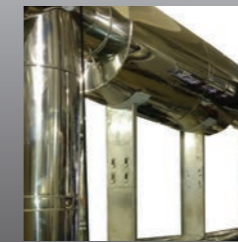

Manifold Heat Insulation



Temperature and Pressure Gauges



Jacket Heat Exchanger



Jacket Water Pump

## TRIGENERATION POWER PACKS

**T**rigeneration is the process of procuring cooling in addition to the electrical and heat outlets of cogeneration systems. In trigeneration systems, hot water or exhaust, exhaust, that are gathered from the engine, are being used to obtain cold water via absorption chillers. The trigeneration system is recommended in such implementations when the heat demand is used seasonally or in such implementations where cooling demand is higher than that of heating demand.

Sole or double effect absorption can be recommended depending on the cooling demand. In system absorption chillers provide cycle efficiency between 0,7 - 1,4 COP, depending on it's working principles.

In Teksan Trigeneration Systems, in addition to the cogeneration packs; absorption chiller, cooling tower and cooling pumps are also presented to the client.

# HYBRID POWER SYSTEMS



Teksan Hybrid system is a complete electrical power supply solution that can be easily configured to meet a broad range of power needs.

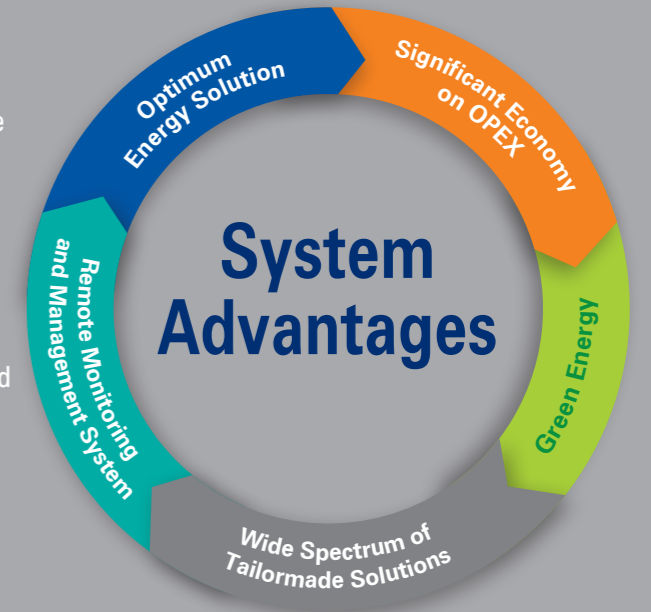

### Optimum Energy Solution

- Special system design gives the flexibility of adding renewable power sources to the system at any time.
- All-in-one design with possible lowest footprint saves significant space
- High tech battery system that is specially engineered for Hybrid power generators ensure the longest and most cost efficient service life.
- Highest charge efficiency and shorter charge time are achieved with unique charging method and latest battery technology.

### Green Energy

- Lower fuel consumption by 65%,
- Reduces CO<sub>2</sub> emission and reduces noise.

### Wide Spectrum of Tailormade Solutions

- Thanks to our engineering know-how, tailormade Project experience, high quality components with contemporary technologies, we deliver high efficiency and sound solutions that matches with the specific needs of your projects.

### Significant Advantage in OPEX

- Lower generator set operating time up to 80%, lower fuel consumption up to 65%,
- Longer service intervals and fewer technical personnel allocation,
- Reduces pay back period of the investment down to 1,5 years,
- Increases utilization period of the system.

### Remote Monitoring and Management System

- It is very handy and cost effective to monitor the performance of operation and to interfere the system in case of need from far distances with Remote Monitoring and Management System supported with GSM and internet technologies,
- You do not have to wait until your technical teams' attainment to the site.

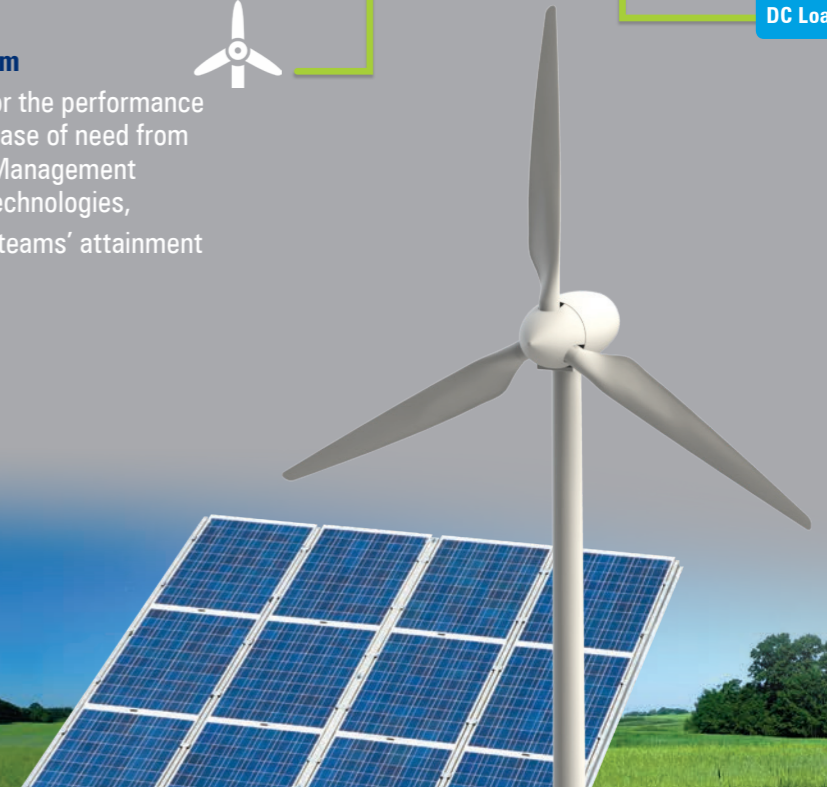
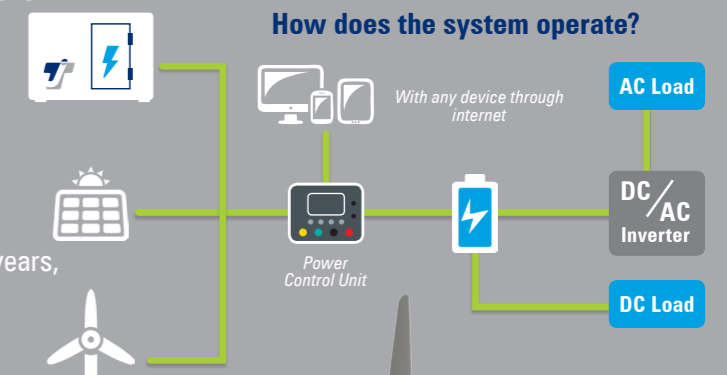

## CONTINUOUS SUPPORT

**T**eksan provides technical support services to its customers through a widespread distribution network.

- Free place and power detection,
- Assembly-disassembly,
- Periodic maintenance,
- Alteration,
- Technical support and advice,
- General maintenance,
- Emergency calls,
- Revision,
- Commissioning,
- Reparation.



### POWER AND PLACE DETECTION

One of the strongest sides of our Technical Service Team is to provide pre-exploration studies for determining energy needs, project designs, purchasing and engineering services including appropriate location selection for the generator sets.

### PERIODIC MAINTENANCE

With the commissioning of generator sets, in the frame of 'General Maintenance Schedule' determined by manufacturer making the checks and maintenance of generator sets, need to change consumables. It is proportional to the run time of the generator with the obligation to make periodic maintenance.

### WHY DO YOU NEED 'PERIODIC MAINTENANCE' CONTRACT?

- Generator sets work long lasting and efficiently,
- The financial and time losses sourced from the company or from the generator set are prevented,
- That provides advantage in planning of spare parts,
- Fast and prime services are offered,
- User-source errors are minimized.



## WE ARE AT YOUR SERVICE



**TEKSAN**

### GUARANTEE

Teksan products are guaranteed for 30 months after the shipment and 2 years or 1000 hours of operation whichever comes first after the first start up against installation and manufacturing defects. Certificate Of Warranty is delivered with generator sets and guarantee process is initiated. Product informations and serial numbers are found in the generator identification label that is on the generator sets.

### SPARE PARTS

For providing better service of generator sets, original spare parts, that are recommended by 'Technical Services Team', should be used. Teksan is providing the best service for meeting needs with sufficient stock level for spare parts.

### TRAINING

Teksan Service Center is offering technical training support to all companies within Teksan Academy. Teksan can organize and conduct the essential trainings upon the request of the partner company with "beginner" or "advanced" content in accordance with the profile of the participants.



# INFINITE POWER SUPPLY TO ENTERPRISES



## POWERFUL TEAM THAT CARRIES OUT SUCCESSFUL PROJECTS!

R&D and Project departments of Teksan are moving together for producing optimal solutions that meet your wishes and needs. They are taking unique results from projects that they developed special for you.



Teksan, which has accumulated extensive knowledge and experienced expert engineer staff, has succeeded in system integration projects with different specifications and has reached the preferred brand in the international arena in special projects.



### Our Project Development Process

- Making the technical analysis of the project specifications,
- Making field and customer visits before and after sales for offering best solution to customer,
- Designing generator sets appropriate with technical parameters as voltage, frequency, altitude, temperature,
- Choosing special equipment for special projects,
- Carrying out of production appropriate with predetermined specification standart and schedule,
- Giving the required education to sales teams, distributors and end users for projects.

### Special Practices

- Product designs at size, power and noise levels that can depend on customer demands,
- Special fuel tank productions,
- Remote radiator practices,
- Special mobile generator sets,
- Seismic solutions,
- Special paint applications.

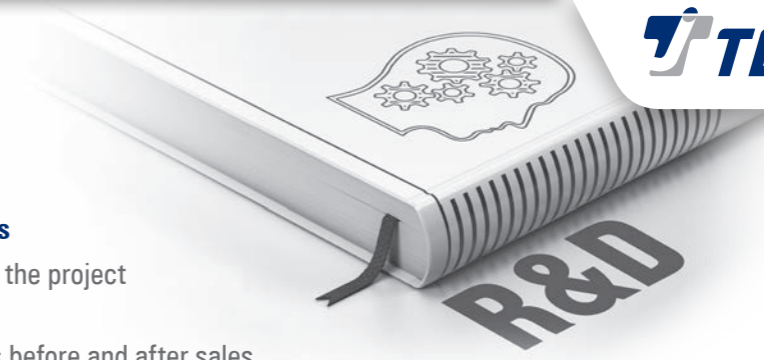
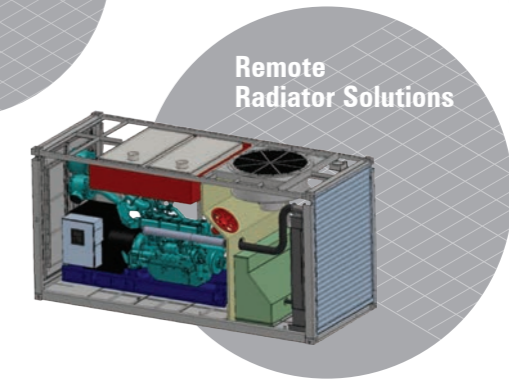
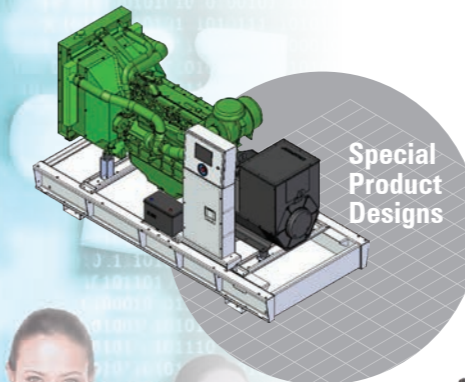

## POWERFUL SOLUTIONS FOR DIFFERENT SECTORS



**Sapphire Residence & Shopping Mall / Istanbul**



**Trabzon Akyazi Stadium / Trabzon**

**Kirikhan State Hospital / Hatay**



**Vialand Entertainment Center / Istanbul**

**T.P.A.O. Silivri / Istanbul**



**Sinpas Altin Oran Complex / Ankara**

2 x 2100 kVA  
Auto Diesel Generator Sets  
2 x 1425 kVA  
Synchronized Diesel Generator Sets

1 x 1900 kVA Auto Diesel Generator Set  
1 x 2065 kVA Auto Diesel Generator Set  
1 x 2200 kVA Auto Diesel Generator Set

6 x 721 kVA  
Synchronized Diesel Generator Sets

17 x 1130 kVA  
Synchronized Diesel Generator Sets

1000 kW  
Natural Gas Generator Set

12 x 500 kVA  
Synchronized Diesel Generator Sets  
4 x 657 kVA  
Synchronized Diesel Generator Sets

**Symbol Kocaeli Shopping Mall Residence-Hospital / Izmit**  
2 x 1900 kVA Synchronized Diesel Generator Sets  
2 x 1400 kVA Synchronized Diesel Generator Sets  
2 x 676 kVA Synchronized Diesel Generator Sets  
1 x 821 kVA Auto Diesel Generator Set  
2 x 821 kVA Synchronized Diesel Generator Sets  
3 x 676 kVA Auto Diesel Generator Sets

**Kepez State Hospital/ Antalya**  
4 x 1650 kVA  
Synchronized Diesel Generator Sets  
2 x 400 kW Trigeration System

**Hatay State Hospital / Hatay**  
5 x 1900 kVA  
Synchronized Diesel Generator Sets

**Sutas Dairy Products Manufacturing Plant / Bursa**  
9 x 45 - 1130 kVA  
Synchronized Diesel Generator Sets

**Viaport Venezia / Istanbul**  
7 x 750 kVA Auto Diesel Generator Sets  
10 x 560 kVA Synchronized Diesel Generator Sets  
8 x 750 kVA Synchronized Diesel Generator Sets

**Istanbul Aquarium / Istanbul**  
1 x 1500 kVA Diesel Generator Set  
1 x 1900 kVA Diesel Generator Set

**Dogus Oto Kartal / Istanbul**  
4 x 552 kVA  
Synchronized Diesel Generator Sets

**Kar Maslak Offices / Istanbul**  
2 x 1600 kVA  
Synchronized Diesel Generator Sets

**Pendik Varyap Plaza / Istanbul**  
3 x 1100 kVA  
Synchronized Diesel Generator Sets

**Varyap Meridian Residence / Istanbul**  
8 x 660 kVA Synchronized Diesel Generator Sets  
8 x 750 kVA Synchronized Diesel Generator Sets  
2 x 880 kVA Synchronized Diesel Generator Sets  
1 x 825 kVA Synchronized Diesel Generator Sets

**Tasyapi Fourwinds Residence / Istanbul**  
6 x 1000 kVA  
Synchronized Diesel Generator Sets

**Anadolu Glass / Mersin**  
2 x 2280 kVA  
Auto Diesel Generator Set

**T.I.G.E.M. / Eskisehir**  
255 kW  
Biogas Cogeneration System

**ACITY Shopping Mall / Ankara**  
4 x 500 kW  
Synchronized Natural Gas Trigeration Sets

**Sinan Erdem Sports Center / Istanbul**  
3 x 1900 kVA  
Synchronized Diesel Generator Sets

**Maiden's Tower / Istanbul**  
1 x 150 kVA Diesel Generator Set

**Carrefoursa Maltepe Park Shopping Mall / Istanbul**  
2 x 1130 kVA Synchronized Diesel Generator Sets  
2 x 905 kVA Synchronized Diesel Generator Sets

**Santa Farma Production Plant / Istanbul**  
3 x 2500 kVA  
Synchronized Diesel Generator Sets

**Anadolu Glass / Eskisehir**  
1 x 2065 kVA  
Synchronized Diesel Generator Set

**Ankara Arena Sports Center / Ankara**  
2 x 1650 kVA  
Synchronized Diesel Generator Sets

**Bostanci Dedeman Hotel / Istanbul**  
4 x 1130 kVA  
Synchronized Diesel Generator Sets

**Hilton Kozyatagi / Istanbul**  
4 x 774 kVA  
Synchronized Diesel Generator Sets

**Igdir Hospital/ Igdir**  
2 x 1000 kVA Synchronized Diesel Generator Sets  
3 x 819 kVA Synchronized Diesel Generator Sets

**Erzurum Airport/ Erzurum**  
2 x 1125 kVA  
Synchronized Diesel Generator Sets

**The Avenue Bodrum Shopping Mall / Bodrum**  
2 x 774 kVA  
Synchronized Diesel Generator Sets

**Brandium Shopping Mall / Istanbul**  
22 x 774 kVA, 4 x 660 kVA  
Synchronized Diesel Generator Sets

**Armada Shopping Mall / Ankara**  
4 x 740 kVA Synchronized Diesel Generator Sets

**Edirne State Hospital / Edirne**  
2 x 430 kW  
Trigeration System

**Sivas State Hospital / Sivas**  
5 x 1650 kVA  
Synchronized Diesel Generator Sets

**Malatya State Hospital /Malatya**  
4 x 1900 kVA  
Synchronized Diesel Generator Sets

**Van Gynaecology Hospital / Van**  
2 x 880 kW  
Cogeneration System

**WOW Convention Center / Istanbul**  
2 x 560 kVA  
Synchronized Diesel Generator Sets

**Izmir Technopark / Izmir**  
1 x 1650 kVA Diesel Generator Set  
1 x 1130 kVA Diesel Generator Set  
1 x 825 kVA Diesel Generator Set

**The Bodrum Museum of Underwater Archaeology / Bodrum**  
1 x 405 kVA Diesel Generator Set

**Tarabya Presidential Campus (Huber Villa) / Istanbul**  
2 x 500 kVA  
Synchronized Diesel Generator Sets

**Topkapi Palace / Istanbul**  
1 x 424 kVA  
Diesel Generator Set

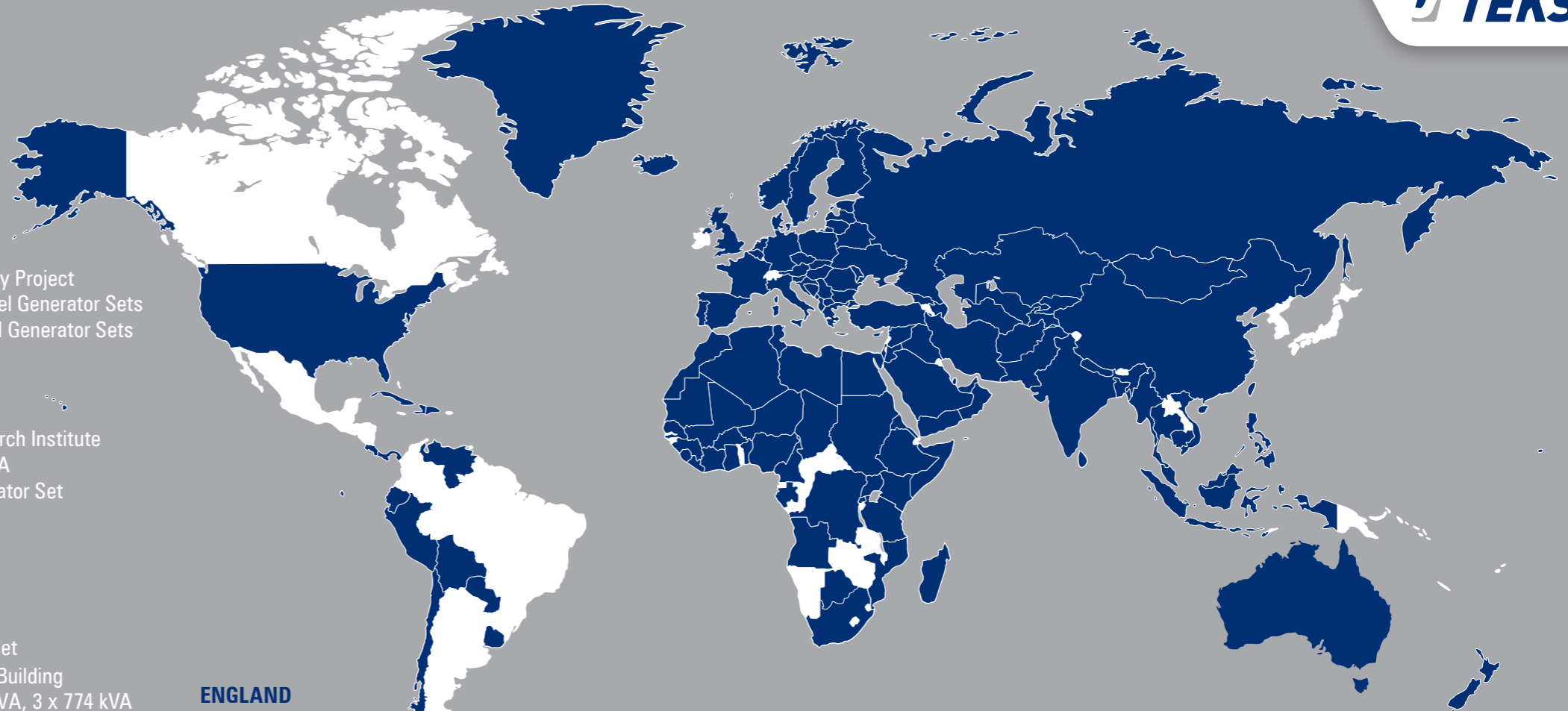

## IN MORE THAN 130 COUNTRIES...

**TURKMENISTAN**

- New Ashgabat International Airport  
36 Units of Standby and Synchronized Diesel GenSets  
Ranging from 145 kVA to 1900 kVA

**GERMANY**

- EMBL Heidelberg Biological Research Institute  
Standby 1000 kVA Diesel Generator Set  
Synchronized with the Main Grid

**BELARUS**

- Prostore Shopping Mall  
Standby 1010 kVA & 680 kVA Auto Diesel Generator Sets  
Container Type Canopy

**BOLIVIA**

- Aguai Sugarworks Production Plant  
Standby 3 x 1400 kVA Synchronized Diesel Generator Sets

**BOTSWANA**

- Botswana Telecom  
Standby 30 x 22-90 kVA Auto Diesel Generator Sets

**BULGARIA**

- Thermal Power Plant  
Standby 2 x 1130 kVA Diesel Generator Sets  
20 ft Container Canopy (Silent)

**GEORGIA**

- Pro Credit Bank  
Standby 2 x 774 kVA Synchronized Diesel Generator Sets

**GREECE**

- Siemens Motorway Project  
2 x 1900 kVA Diesel Generator Sets  
2 x 660 kVA Diesel Generator Sets

**GREENLAND**

- Zackenberg Research Institute  
Standby 1 x 27 kVA Auto Diesel Generator Set  
0°C Cold Start

**HOLLAND**

- Vodafone Arnheim  
Standby 1010 kVA Diesel Generator Set
- Duo2 Consortium Building  
Standby 2 x 905 kVA, 3 x 774 kVA Synchronized Diesel Generator Sets
- Provincial Waterworks Andjik  
Standby 4 x 2200 kVA Synchronized Diesel Generator Sets

**NETHERLAND ANTILLES**

- Lions Dive & Beach Resort Curacao  
Standby 560 kVA Diesel Generator Sets

**IRAQ**

- Basra Oil Reservoir  
Prime 9 x 2500 kVA Synchronized Diesel Generator Sets
- Sulaymaniyah Hospital  
Standby 3 x 1650 kVA Synchronized Diesel Generator Sets
- Najaf Al-Furat & Almanathire Hospitals  
Standby 4 x 2280 kVA, 2 x 1400 kVA Synchronized Diesel Generator Sets
- Erbil Italian Village  
Standby 3 x 1135 kVA Synchronized Diesel Generator Sets

**ENGLAND**

- Southmead Hospital  
Standby 2 x 1035 kVA Integrated with Building Management Systems  
Silent Canopy

**KAZAKHSTAN**

- Dostyk Plaza  
Standby 2 x 2025 kVA Auto Diesel Generator Sets  
Container Type Canopy

**QATAR**

- Samko Engineering Doha  
Standby 3 x 1000 kVA Diesel Generator Sets

**KENYA**

- Safari Hotel  
Standby 2 x 400 kVA Diesel Generator Sets  
Cogeneration:  
Prime 4 x 275 kVA Diesel Generator Sets

**LIBYA**

- Artificial River Projects  
Standby 2 x 275 kVA Diesel Generator Sets

**EGYPT**

- Savola Desert Irrigation Project  
Standby 77 x 330 kVA  
No exhalation even in the hottest climate special filtration against sand storms  
Diesel Generator Sets

**NEPAL**

- Fort Resort Hotel  
1 x 180 kVA  
Altitude of 2.200 meters  
Diesel Generator Set

**ROMANIA**

- Tower Business Center  
Standby 400 kVA and 1125 kVA Remote Radiator  
Diesel Generator Set

**RUSSIA**

- AURA Shopping Mall-Plaza  
1500 kVA Diesel Generator Set

**RWANDA**

- Serena Hotel  
3 x 700 kVA Synchronized Diesel Generator Sets

**SUDAN**

- Ferronile Steel Factory  
Standby 3 x 2120 kVA, 2 x 1915 kVA Synchronized Diesel Generator Sets

**SAUDI ARABIA**

- Rejal Alma Sewage Treatment Plant  
Standby 1400 kVA ISO Type / Canopied Diesel Generator Sets
- Mövenpick Hotel Jeddah  
Standby 1 x 1400 kVA Synchronized Diesel Generator Sets

**TANZANIA**

- Vodafone  
Standby 2 x 1130 kVA Diesel Generator Sets  
30 ft Container Type Canopy

**THAILAND**

- CCZ Hospital  
Standby 1900 kVA Auto Diesel Generator Sets

**UKRAINE**

- Ukgazbank  
Standby 520 kVA Diesel Generator Sets

**NEW ZEALAND**

- Standby 1010 kVA Diesel Generator Set parallel with the main grid  
30 ft Container



*Savola Desert Irrigation Project / Egypt*  
Standby 77 x 330 kVA  
No overheating even in the hottest climate  
Diesel Generator Sets

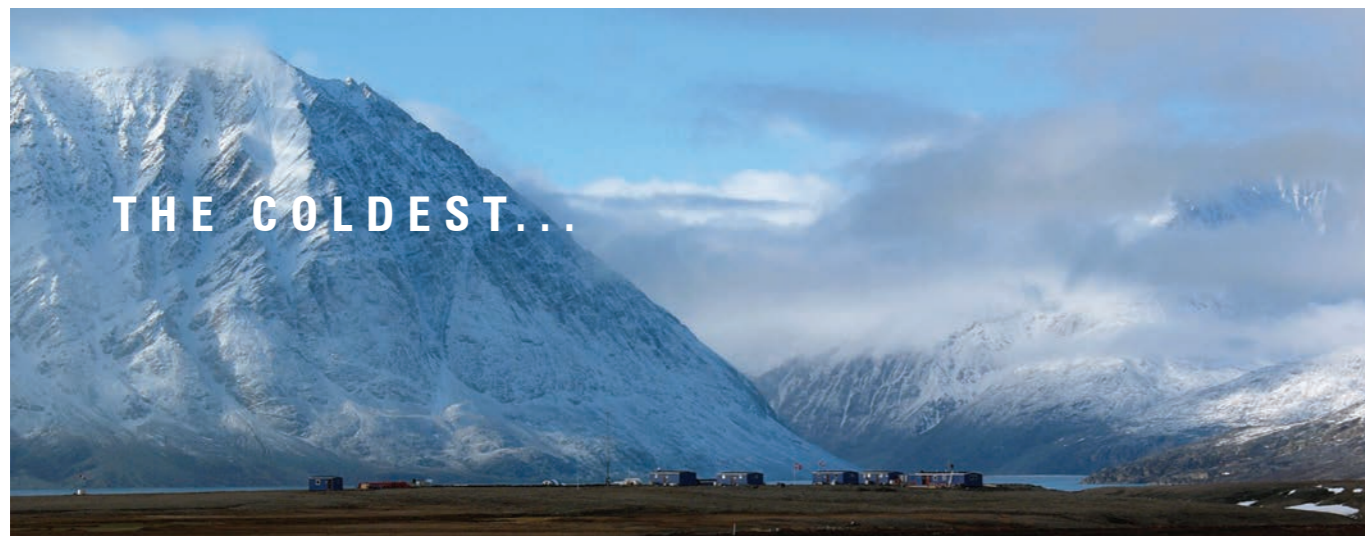

*Zackenberg Research Institute / Greenland*  
Standby 1 x 27 kVA  
0°C cold start  
Auto Diesel Generator Set



*Fort Resort Hotel / Nepal*  
1 x 180 kVA  
Operating at higher altitude (2200 + meters)  
Diesel Generator Set

**TEKSAN IS ALWAYS WITH YOU...**





**EVERLASTING  
COMPANY**

TURKEY HEADQUARTER



+90 **444 8576**  
[www.teksan.com](http://www.teksan.com)  
[info@teksan.com](mailto:info@teksan.com)

USA BRANCH OFFICE



+1 224 **404 1274**  
[www.teksanus.com](http://www.teksanus.com)  
[info@teksanus.com](mailto:info@teksanus.com)